

Varenummer: 20055515  
 Beskrivelse: E+G Kobling for radial forskydning  
 GN 240-M20-B

## Mål

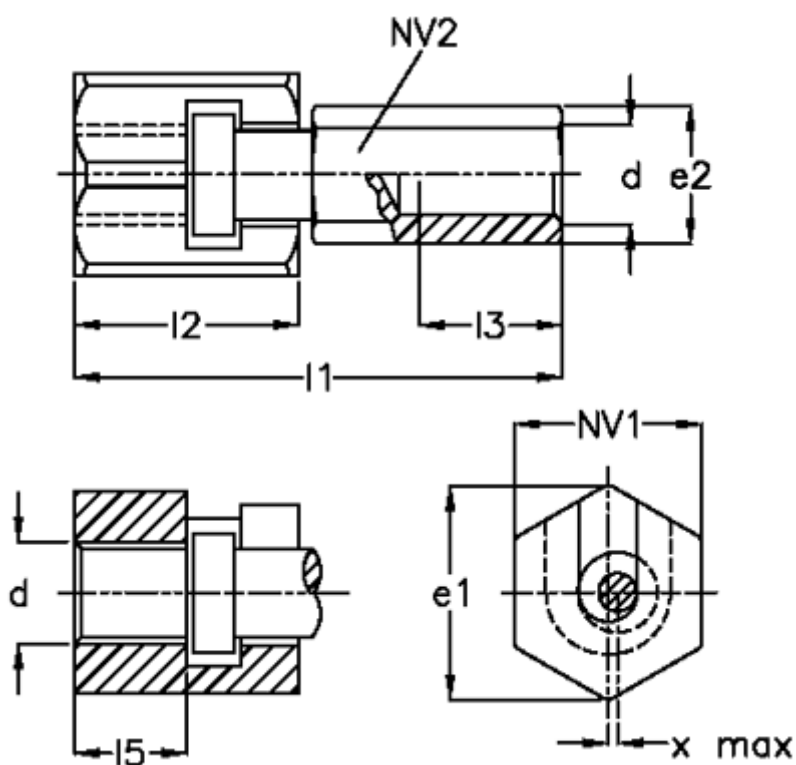

d	= M 20x2,5	Max træk-skub kraft N = 30000
e1	= 44.0	NV 1 = 41
e2	= 34.0	NV 2 = 30
l1	= 93.5	
l2	= 45.5	
l3	= 29.0	
l5 +1	= 23.5	
Max forskydning = 1.0		